



LEOPARD











| MOD. | PRECIO / PRICE |
|--------|----------------|
| BLE700 | 23645 € |
| BLE750 | 24190 € |
| BLE800 | 24915 € |

 Desbrozadora hidráulica profesional, para tractores de 110 a 150 CV, idónea para limpieza de fosos, zanjas y bordes de la vía pública.

 Professional hydraulic bush-cutter for tractors from 110 to 150 HP, suitable for cleaning street edges, embankments and parks.

 Épareuse hydraulique pour tracteurs de 110 à 150 CV, adaptée au nettoyage de talus, fossés et bords de route.

 Hydraulische Böschungsmäher für Gras, Vegetation und Gebüsch für Traktoren von 110 bis 150 PS.

| ACCESORIOS / ACCESSORIES | PRECIO / PRICE |
|---|---|
| BAC022 Acumulador de nitrógeno en brazo rotación Nitrogen accumulator in turning arm Boule d'azote dans le bras de rotation Stickstoffe Akkumulator bei der Drehung des Armes | 725 € |
| BAC024 Transmisión por correas Belts transmission Entrainement par courroies Antrieb über Riemen | 1480 € |
| BAC036 Mandos eléctricos proporcionales (joystick) Electric commandment proportional (joystick) Commandement électrique proportional (joystick) Proportional elektrische Bedienung (Joystick) | 5580 € |
| BAC038 Rotación adicional del cabezal 90° Additional rotation of the mulching head 90° Rotation supplémentaire de la tête 90° Selbstdrehender Mulchkopf bis zu 90° | 2010 € |
| COD.7003 Hierba y madera max. 6 cm Grass and branches max. 6 cm Herbe et bois max. 6 cm Gras und Holz max. 6 cm |  de serie serial device |
| BAC004 Hierba y madera max 3 cm - COD.7001 Grass and branches max. 3 cm - COD.7001 Herbe et bois max. 3 cm - COD.7001 Gras und Holz max. 3 cm - COD.7001 |  + 130 € |
| BAC005 Hierba y madera max. 4 cm - COD.7002 Grass and branches max. 4 cm - COD.7002 Herbe et bois max. 4 cm - COD.7002 Gras und Holz max. 4 cm - COD.7002 |  + 150 € |
| BAC006 Hierba y madera max 8 cm - COD.7004 Grass and branches max. 8 cm - COD.7004 Herbe et bois max. 8 cm - COD.7004 Gras und Holz max. 8 cm - COD.7004 |  + 440 € |
| BAC007 Hierba y madera max 4 cm - COD.7012 Grass and branches max. 4 cm - COD.7012 Herbe et bois max. 4 cm - COD.7012 Gras und Holz max. 4 cm - COD.7012 |  + 220 € |
| BAC008 Hierba y madera max 4 cm - COD.7014 Grass and branches max. 4 cm - COD.7014 Herbe et bois max. 4 cm - COD.7014 Gras und Holz max. 4 cm - COD.7014 |  + 270 € |
| BAC009 Hierba y madera max 4 cm - COD.7011 Grass and branches max. 4 cm - COD.7011 Herbe et bois max. 4 cm - COD.7011 Gras und Holz max. 4 cm - COD.7011 |  + 0 € |
| BAC044 Hierba y madera max 6 cm - COD.7016 Grass and branches max. 6 cm - COD.7016 Herbe et bois max. 6 cm - COD.7016 Gras und Holz max. 6 cm - COD.7016 |  + 915 € |

EQUIPAMIENTO DE SERIE



STANDARD EQUIPMENT



- Mandos a distancia teleflexibles (3000 mm).
- Instalación hidráulica independiente.
- Sistema anti-golpe hidráulico.
- Rodillo trasero regulable en altura.
- Transmisión directa en todos los modelos.
- Adaptación del cabezal al terreno.
- Barra con luces.
- Kit bomba y motor en fundición (60 CV).
- Patines.
- Cardan.
- Tensores de regulación.
- Intercambiador de calor.
- Rotación hidráulica de seguridad 90°.
- Cabezal telescópico.
- Rotación reversible del rotor.
- Protecciones para evitar accidentes según normas CE.

- Teleflexible remote commandment (3000 mm).
- Independent hydraulic installation.
- Hydraulic anti-shock device.
- Height adjustable back roller.
- Direct transmission in all models.
- Floating.
- Lights.
- Kit pump and engine power in smelting (HP 60) Skids.
- Cardan joint.
- Tractor stabilizers.
- Oil culer.
- Heat exchanger.
- Safety device hydraulic rotation 90°.
- Telescopic head.
- Reversible rotation of the rotor.
- Accident prevention protections according to EC directives.

EQUIPEMENT STANDARD



GRUNDAUSSTATTUNG



- Commandement teleflexible à distance (3000 mm).
- Installation hydraulique indépendante.
- Système anti-choc hydraulique.
- Rouleau arrière réglable en hauteur.
- Transmission directe dans tous modèles.
- Flottant sur la tête.
- Pare-chocs avec feux.
- Kit pompe et moteur en fonte (60 CH).
- Patins.
- Cardan.
- Tendeurs de réglage.
- Radiateur.
- Rotation hydraulique de sécurité 90°.
- Tête télescopique.
- Rotation réversible du rotor.
- Protections selon normes CE.

- Teleflexible Fernbedienung (3000 mm).
- Hydraulische unabhängige Installation.
- Hydraulische Anti-Schock System.
- In der Höhe verstellbarer Stützwalzer.
- Direkter Antrieb in allen Modellen.
- Floating.
- Stange mit Lichtern.
- Kit Pumpe und tGussmotor (60 PS).
- Kufen.
- Gelenkwelle.
- Spannvorrichtungen.
- Wärmetauscher.
- Hydraulische Sicherheitsrotation 90°.
- Teleskopischer Kopf.
- Reversible Rotation des Rotors.
- Unfallschutzvorrichtungen gemäß CE-Normen.



| MOD. | KG | R.P.M. | LT | KG | C.V. | CM |
|--------|------|--------|-----|------|---------|-----|
| BLE700 | 1390 | 540 | 230 | 5000 | 110/130 | 210 |
| BLE750 | 1430 | 540 | 230 | 5500 | 120/140 | 220 |
| BLE800 | 1470 | 540 | 230 | 5800 | 130/150 | 220 |

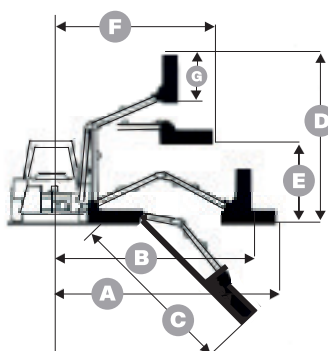

| | A | B | C | D | E | F | G |
|--------|------|------|------|------|------|------|------|
| MOD. | MM | MM | MM | MM | MM | MM | MM |
| BLE700 | 7000 | 6650 | 5800 | 7200 | 3200 | 4300 | 1200 |
| BLE750 | 7500 | 7150 | 6300 | 7700 | 3500 | 4450 | 1200 |
| BLE800 | 8000 | 7650 | 6800 | 8200 | 3600 | 4600 | 1200 |